

AYC-Ex5/T65 Family

Convertible Backlit Proximity & PIN Readers/Controllers

Installation and Programming Manual

Ex5 Models:

AYC-E55

AYC-E65BB

AYC-E65BG

AYC-E65BW

T65 Models:

AYC-T65B

AYC-T65N

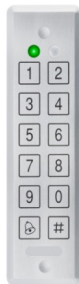

AYC-Ex5



AYC-T65

Copyright © 2014 by Rosslare. All rights reserved.

This manual and the information contained herein are proprietary to ROSSLARE ENTERPRISES LIMITED and/or its related companies and/or subsidiaries' (hereafter: "ROSSLARE"). Only ROSSLARE and its customers have the right to use the information.

No part of this manual may be re-produced or transmitted in any form or by any means, electronic or mechanical, for any purpose, without the express written permission of ROSSLARE.

ROSSLARE owns patents and patent applications, trademarks, copyrights, or other intellectual property rights covering the subject matter in this manual.

TEXTS, IMAGES, AND ILLUSTRATIONS INCLUDING THEIR ARRANGEMENT IN THIS DOCUMENT ARE SUBJECT TO THE PROTECTION OF COPYRIGHT LAWS AND OTHER LEGAL RIGHTS WORLDWIDE. THEIR USE, REPRODUCTION, AND TRANSMITTAL TO THIRD PARTIES WITHOUT EXPRESS WRITTEN PERMISSION MAY RESULT IN LEGAL PROCEEDINGS.

The furnishing of this manual to any party does not give that party or any third party any license to these patents, trademarks, copyrights or other intellectual property rights, except as expressly provided in any written agreement of ROSSLARE.

ROSSLARE reserves the right to revise and change this document at any time, without being obliged to announce such revisions or changes beforehand or after the fact.

Table of Contents

1. Introduction	9
1.1 Key Features	9
1.1.1 Reader	10
1.1.2 Controller	10
1.2 Reader/Controller Types.....	11
1.3 Box Content	12
1.4 Ancillary Equipment	12
1.4.1 Reader	12
1.4.2 Controller	12
2. Technical Specifications	13
3. Installation	15
3.1 Mounting Instructions	15
3.2 Wiring Instructions	16
4. Reader Functionality	20
4.1 Transmit Mode	20
4.2 Programming the AYC-Ex5 and AYC-T65.....	20
4.2.1 Entering Programming Mode.....	22
4.2.2 Exiting Programming Mode	22
4.2.3 Selecting Keypad Transmission Format	23
4.2.4 Selecting Proximity Card Transmission Format	29
4.2.5 Changing the Programming Code	31
4.2.6 Changing the Facility Code	31
4.3 Setting the Backlight	32
4.4 Return to Factory Default Settings.....	33

Table of Contents

4.5	Replacing a Lost Programming Code	34
5.	Controller Functionality.....	35
5.1	Normal, Secure, and Master Users.....	35
5.2	Modes of Operation	36
5.2.1	Normal Mode	36
5.2.2	Bypass Mode	36
5.2.3	Secure Mode	37
5.2.4	Changing the Modes of Operation	37
5.3	Auxiliary Input and Output.....	38
5.4	Door Alarms	39
5.5	Internal Case and Back Tamper	39
5.6	Lockout Feature (Keypad Tamper)	39
5.7	REX Function	39
5.8	Secure Application Appurtenances.....	40
5.9	Programming the AYC-Ex5 and AYC-T65.....	40
5.9.1	Entering Programming Mode.....	41
5.9.2	Exiting Programming Mode	42
5.9.3	Changing Lock Strike Code	42
5.9.4	Changing Auxiliary Code	43
5.9.5	Changing the Programming Code	44
5.9.6	Changing the Normal/Secure Code	44
5.9.7	Changing the Normal/Bypass Code and Door Chime Settings.....	45
5.9.8	Setting Fail Safe/Secure Operation, Tamper Siren and Lock Strike Release Time.....	46
5.9.9	Defining the Auxiliary Input and Output	47
5.9.10	Detailed Reference Guide	49
5.9.11	Setting the Lockout Feature.....	53
5.9.12	Setting the Backlight Behavior	54

Table of Contents

5.9.13	Enrolling Primary and Secondary Codes	54
5.9.14	Deleting Primary and Secondary Codes.....	58
5.9.15	Relay Codes Assignment.....	60
5.9.16	Relay Code Assignment using Standard Method	60
5.9.17	Relay Code Assignment using Search Method	61
5.9.18	PIN Code Length/Factory Default Settings.....	62
5.9.19	Replacing a Lost Programming Code	63
5.9.20	Exiting Secure Mode if Normal/Secure Code was Lost.....	63
A.	Declaration of Conformity.....	64
B.	Limited Warranty	65

List of Figures

Figure 1: Drilling and Mounting Template	15
Figure 2: Controller Application Wiring Diagram	17
Figure 3: Auxiliary Output Connection with Internal Power	18
Figure 4: Auxiliary Output Connection with External Power.....	18
Figure 5: Reader Application Wiring Diagram	19

List of Tables

Table 1: Wiring Colors.....	16
Table 2: Reader Programming Menus.....	21
Table 3: Keypad Transmission Format Option Number	24
Table 4: Controller Programming Menu	41
Table 5: Quick Reference Guide for Auxiliary Mode Setting.....	48

Notice and Disclaimer

This manual's sole purpose is to assist installers and/or users in the safe and efficient installation and usage of the system and/or product, and/or software described herein.

BEFORE ATTEMPTING TO INSTALL AND/OR USE THE SYSTEM, THE INSTALLER AND THE USER MUST READ THIS MANUAL AND BECOME FAMILIAR WITH ALL SAFETY REQUIREMENTS AND OPERATING PROCEDURES.

- The system must not be used for purposes other than those for which it was designed.
- The use of the software associated with the system and/or product, if applicable, is subject to the terms of the license provided as part of the purchase documents.
- ROSSLARE exclusive warranty and liability is limited to the warranty and liability statement provided in an appendix at the end of this document.
- This manual describes the maximum configuration of the system with the maximum number of functions, including future options. Therefore, not all functions described in this manual may be available in the specific system and/or product configuration you purchased.
- Incorrect operation or installation, or failure of the user to effectively maintain the system, relieves the manufacturer (and seller) from all or any responsibility for consequent noncompliance, damage, or injury.
- The text, images and graphics contained in the manual are for the purpose of illustration and reference only.
- All data contained herein subject to change without prior notice.
- In no event shall manufacturer be liable for any special, direct, indirect, incidental, consequential, exemplary or punitive damages (including, without limitation, any and all damages from business interruption, loss of profits or revenue, cost of capital or loss of use of any property or capital or injury).
- All graphics in this manual are for reference only, some deviation between the image(s) and the actual product may occur.
- All wiring diagrams are intended for reference only, the photograph or graphic of the PCB(s) are intended for clearer illustration and understanding of the product and may differ from the actual PCB(s).

1. Introduction

The AYC-Ex5/T65 series are vandal-resistant, integrated convertible readers and controllers with a piezoelectric keypad.

These units automatically determine whether to function as a reader or as a controller. If the unit is connected to a standard access control unit, then it functions as a reader. If the unit is connected to Rosslare's secure application appurtenances such as the PS-A25T, PS-C25T or PS-C25TU, it functions as a secured controller.

For information on how the unit functions as a reader, see Chapter 4. For information on how the unit functions as a controller, see Chapter 5.

The unit is vandal resistant and water resistant, suitable for indoor or outdoor mounting.

As a controller, the units accept up to 500 users, and allow entry via a personal identification number (PIN) and/or by presenting a proximity card. The PIN code length for the controller has several options. The PIN code length can be a set number of 4, 5, or 6 digits or it can be a 4- to 8-digit option.

This manual contains the following information:

- Installation
- Wiring instructions
- Operation Instructions

1.1 Key Features

The key features for the AYC-Ex5/T65 series are:

- Ultra-slim flush-mount design on flat surface (AYC-Ex5 Family)
- Built-in piezoelectric keypad for PIN code entry
- Built-in 125 kHz ASK EM proximity card reader (AYC-E65B, AYC-E65BB, AYC-T65)
- Programmable patented blue backlit keypad (AYC-E65B, AYC-E65BB, AYC-T65)

Introduction

- Optical back tamper sensor and open collector tamper output
- Lockout feature on wrong entries (keypad tamper)
- Internal buzzer provides audible interface feedback
- Two status/programming interface LEDs (tri-colored)
- Fully potted construction for outdoor use
- Comes with mounting template for easier installation
- Comes with an installation kit that includes a security screw and a security screw tool

1.1.1 Reader

- Programmable keypad transmission format
- Programmable card transmission formats: Clock & Data and Wiegand 26-Bit (AYC-E65B, AYC-E65BB, AYC-T65)
- LED control input
- Programmable Facility code

1.1.2 Controller

- Bi-directional secure communication with Rosslare's secure application appurtenance
- Three User Levels:
 - Normal User
 - Secure User
 - Master User
- "Code Search" feature that helps make maintaining user codes easier
- Three modes of operation:
 - Normal mode
 - Bypass mode
 - Secure mode
- REX signal from Rosslare's secure application appurtenance

- Chime bell and siren features are available with secure application appurtenance
- Programmable Lock Strike Release, Siren, and Alarm Delay timers
- Programmable Auxiliary input with versatile functions
- Programmable Auxiliary output functions
- Programmable PIN code length

1.2 Reader/Controller Types

The different types of units described in this manual are:

- Type E55 has PIN only
- Type E65 and T65 have PIN and proximity card

	Backlight	Keypad Type	Proximity
AYC-E55	<input type="checkbox"/>	Piezoelectric	<input type="checkbox"/>
AYC-E65B	<input checked="" type="checkbox"/>	Piezoelectric	<input checked="" type="checkbox"/>
AYC-E65BB	<input checked="" type="checkbox"/>	Piezoelectric	<input checked="" type="checkbox"/>
AYC-T65	<input checked="" type="checkbox"/>	Piezoelectric	<input checked="" type="checkbox"/>

Upon power-on reset, the AYC-Ex5 and AYC-T65 units search for the presence of Rosslare's secure application appurtenances. If a secure application appurtenance is detected, then the unit is automatically configured as a secure access control unit. This is indicated by two short beeps. If the secured controller is not detected, it is automatically configured as a reader, indicated by one short beep.

1.3 Box Content

Before beginning verify that all of the following is in the box. If anything is missing, please report the discrepancy to your nearest Rosslare office.

- One AYC-Ex5/T65 unit
- Installation kit
- Installation and operating instructions
- Secure application appurtenance (optional for controller applications)

1.4 Ancillary Equipment

The following equipment is required to complete your installation:

1.4.1 Reader

- Compatible host controller (not supplied) – UL listed access control unit, such as model AC-215U

1.4.2 Controller

- Secure application appurtenances (such as the PS-A25T, PS-C25T or PS-C25TU secure controllers)

The controller connects to the following:

- Electric lock strike mechanism or a magnetic lock device, which implements fail safe (power to lock) or fail secure (power to open) functions.
- Request-to-Exit (REX) button – normally open type
Switch is closed when pressed.
- Door monitor switch

Rosslare accessories can be found on www.rosslaresecurity.com.

2. Technical Specifications

Specification	AYC-E55	AYC-E65B, AYC-E65BB	AYC-T65
Electrical Characteristics			
Power Supply Type	Linear type (recommended)		
Operating Voltage Range	5–16 VDC (when used as a controller, provided by the secure application appurtenance)		
Input Current Standby	15 m A@12 VDC	92 mA @12 VDC	
Max Input Current	40 mA @16 VDC	105 mA @16 VDC	
LED Control Input	Dry contact N.O.		
Tamper Output	Open collector, active low, 30 mA max sink current		
Cable Distance to Host Controller	Up to 500 ft. (150 meters) using an 18 AWG cable		
Max. Proximity Card Read Range*	N/A	40 mm (1.58 in.)	
Proximity Card Modulation	N/A	ASK at 125 kHz	
Proximity Card Compatibility	N/A	EM cards	
Card Transmit Format (Reader)	N/A	Wiegand 26-Bit, or Clock & Data	
Keypad Transmit Format (Reader)	Programmable PIN code formats		
LED Indicators	Two tri-colored LEDs		
Communication	Data1/C1, Data0/C2—open collector, 5 V termination		

Technical Specifications

Specification	AYC-E55	AYC-E65B, AYC-E65BB	AYC-T65
----------------------	----------------	--------------------------------	----------------

Environmental Characteristics

Operating Temp. Range	-30°C to 65°C (-22°F to 150°F)		
Operating Humidity Range	0 to 95% (non-condensing)		
Outdoor Usage	Weather-resistant, meets IP68, epoxy-potted, suitable for outdoor use		

Physical Characteristics

Size (Height x Width x Depth)	155 x 44 x 6.5 mm (6.1 x 1.73 x 0.26 in.)	155 x 44 x 9 mm (6.1 x 1.73 x 0.35 in.)	121 x 70 x 8 mm (4.77 x 2.76 x 0.31 in.)
Weight	120 g (4.23 oz)	143 g (5.04 oz)	121 g (4.27 oz)

* Measured using a Rosslare proximity card or equivalent. Range also depends on electrical environment and proximity to metal.

3. Installation

3.1 Mounting Instructions

Before starting, select the location to mount the unit. This location should be at shoulder height.

To mount the unit:

1. For wall mounting, use the included mounting template as a guide for drilling holes for mounting screws and wiring (Figure 1). For US Gang Box mounting, no drilling is necessary.

Figure 1: Drilling and Mounting Template

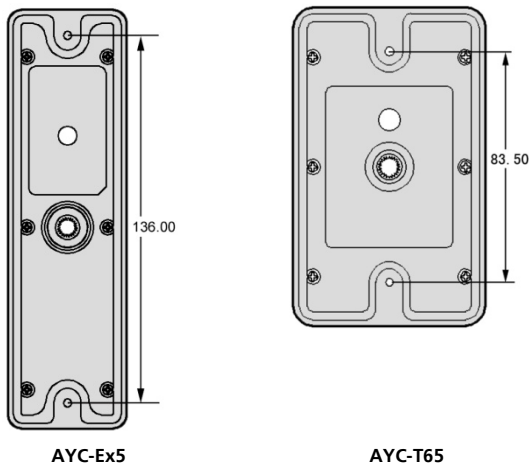

Installation

- When the unit is used as a reader, route the interface cable from the unit to the controller; when the unit is used as a secured controller, route the interface cable from the unit to Rosslare's secure application appurtenance (see Section 3.2). A linear type power supply is recommended, when using the unit as a controller.
- Screw the unit to its mounting location or US gang box.

3.2 Wiring Instructions

The unit is supplied with a 1.5-m (60") pigtail, having a 6-conductor cable.

To connect the unit to the controller:

- Prepare the unit's cable by cutting the cable jacket back 3.2 cm (1¼") and stripping the wire 1.3 cm (½").
- Prepare the controller cable by cutting the cable jacket back 3.2 cm (1¼") and stripping the wire 1.3 cm (½").
- Splice the unit's pigtail wires to the corresponding controller wires and cover each connection.

Refer to Table 1 and to the wiring diagrams provided on the following pages.

Table 1: Wiring Colors

Reader	Controller	Color	Functionality
5~16 VDC	5~16 VDC	Red	+DC Input
Shield/Ground	Shield/Ground	Black	Ground
Data 1/Clock	C 1	White	Communication
Data 0/Data	C 2	Green	Communication
LEDCTL	AUX. IN	Brown	LED Control/Auxiliary Input
Tamper	Tamper	Purple	Tamper

4. If the tamper output is used, connect the purple wire to the correct input on the controller when used as a reader, or to a zone input of an intruder alarm system when used as a controller.
5. Trim and cover all unused conductors.



- The individual wires from the unit are color-coded according to the Wiegand standard.
- When using a separate power supply for the reader, this power supply and that of the controller must have a common ground.
- The reader's cable shield wire should preferably be attached to an earth ground, or a signal ground connection at the panel, or power supply end of the cable. This configuration is best for shielding the reader cable from external interference

Figure 2 shows the wiring for the controller application using a dual relay secure application appurtenance.

Figure 2: Controller Application Wiring Diagram

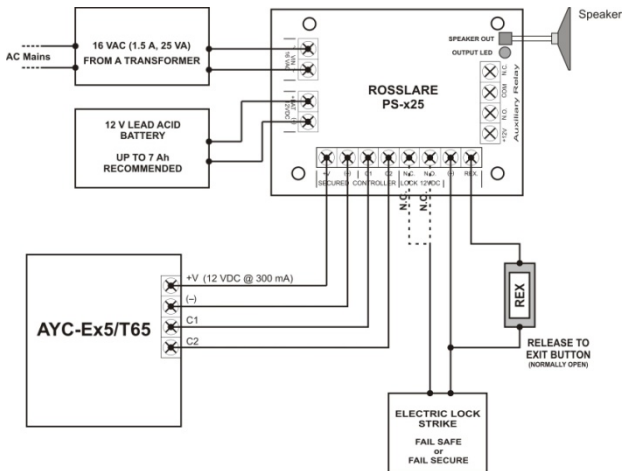

Figure 3 shows the auxiliary output connection using internal power.

Figure 3: Auxiliary Output Connection with Internal Power

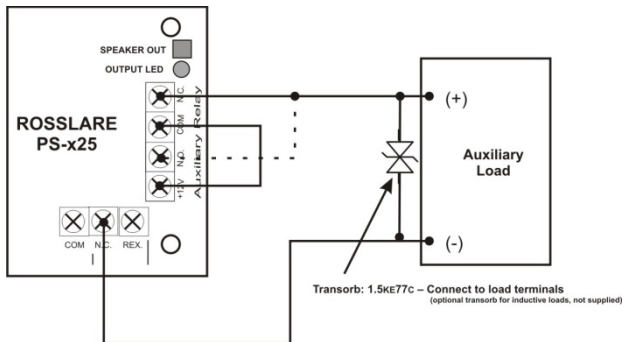

Figure 4 shows the auxiliary output connection using external power.

Figure 4: Auxiliary Output Connection with External Power

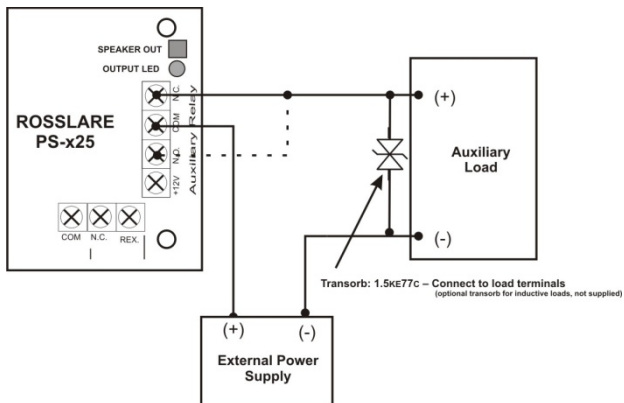
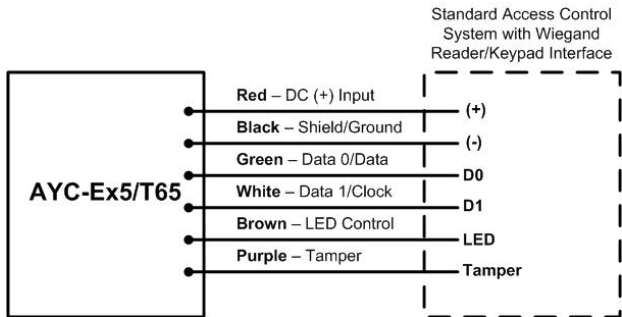

Figure 5 shows how to wire a reader to the access control panel.

Figure 5: Reader Application Wiring Diagram



4. Reader Functionality



The AYC-Ex5 series and the AYC-T65 can function both as a reader and as a controller. If the unit is connected to standard access controller, it functions as a reader, indicated by one beep immediately after power-on reset.

The following explains how the AYC-Ex5 and AYC-T65 function as a reader.

4.1 Transmit Mode

When the unit is in Transmit mode, it is ready to receive data from a presented proximity card or an entered PIN code.

When the reader is in Transmit mode, the Transmit LED is red and the Program LED is off.

Mode/Transmit   Door/Program
Red

When a proximity card or PIN entry is being transmitted, the Transmit LED flashes green.

Keyboard data can be sent via one of eight different Keypad Transmission Formats (see Section 4.2.3).

Proximity cards presented to the reader are always sent in either Wiegand 26-Bit, Clock & Data or, Wiegand Card + PIN format (see Section 4.2.4).

4.2 Programming the AYC-Ex5 and AYC-T65

Programming the AYC-Ex5 and AYC-T65 is done solely via the unit's keypad driven Programming Menu System. During the unit's manufacturing process, certain codes and settings are pre-programmed. These settings are called the default factory settings.

Table 2 shows the names of all the AYC-Ex5 and AYC-T65 reader menus.

Default factory settings are marked by a "*" sign.

Table 2: Reader Programming Menus

Menu Description	Default
1 Selecting Keypad Transmission Format Single Key, 6-Bit Wiegand (Rosslare Format) Single Key, 6-Bit Wiegand with Nibble + Parity Bits Single Key, 8-Bit Wiegand, Nibbles Complemented 4 Keys Binary + Facility Code, Wiegand 26-Bit 1 to 5 Keys + Facility Code, Wiegand 26-Bit 6 Keys BCD and Parity Bits, Wiegand 26-Bit Single Key, 3x4 Matrix Keypad 1 to 8 Keys BCD, Clock & Data	*
2 Selecting Card Transmission Format Wiegand 26-Bit Clock & Data Wiegand Card + PIN	*
3 Changing the Programming Code	1234
4 Changing the Facility Code	0
6 Backlight Options Off On (default) Off until key press when on for 10 seconds Dimmed until key press when on for 10 seconds	*
0 Return to Factory Default Settings	

4.2.1 Entering Programming Mode

To reach the Programming Menu System, the unit must first be placed into Programming mode.

To enter Programming mode:

1. Press **#** four times.

The Transmit LED turns off and the Program LED turns red.

Mode/Transmit Door/Program
Red

2. Enter your 4-digit Programming code.

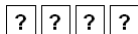

If the Programming code is valid, the door LED turns green and the unit is in Programming mode.

Mode/Transmit Door/Program
Green



- The factory 4-digit Programming code is 1234.
- If a Programming code is not entered within 30 seconds, the unit returns to Transmit mode.

4.2.2 Exiting Programming Mode

To exit Programming mode:

1. Press **#** to exit the Programming mode at any time.

- You hear a beep.
- The Program LED turns off and the Transmit LED turns red.

Mode/Transmit Door/Program
Red

This indicates that the unit has returned to Transmit mode.

Wrong entries may reset the reader back to Transmit mode.

While in Programming mode, if no key is pressed for 30 seconds, the unit exits Programming mode and returns to Transmit mode.

4.2.3 Selecting Keypad Transmission Format

The AYC-Ex5 and AYC-T65 have eight different keypad transmission formats.

See Table 3 in Section 4.2.3.1 for more information on keypad transmission formats.

To select the appropriate keypad transmission format:

1. Enter Programming mode. Mode/Transmit Door/Program
Green

2. Press **1** to enter Menu 1.

The Transmit LED turns red.

Mode/Transmit Door/Program
Red Green

3. Enter the appropriate option number for the keypad transmission format that you wish to select.

You hear three beeps.

The system returns to Transmit mode.

Mode/Transmit Door/Program
Red

If an incorrect option number is entered, the reader returns to Transmit mode and the keypad transmission format remains unchanged.



- Only one keypad transmission format can be active at any one time.
- When using the keypad transmission format "1 to 8 keys BCD, Clock & Data" (Option 8), an additional input is required to specify the number of keys in the PIN code.

4.2.3.1 Keypad Transmission Format Option Number

Table 3 presents the eight different keypad transmission formats.

Table 3: Keypad Transmission Format Option Number

Keypad Transmission Format	Option Number
Single Key, 6-Bit Wiegand (Rosslare Format)	1*
Single Key, 6-Bit Wiegand with Nibble + Parity Bits	2
Single Key, 8-Bit Wiegand, Nibbles Complemented	3
4 Keys Binary + Facility Code, Wiegand 26-Bit	4
1 to 5 Keys + Facility Code, Wiegand 26-Bit	5
6 Keys BCD and Parity Bits, Wiegand 26-Bit	6
Single Key, 3x4 Matrix Keypad	7
1 to 8 Keys BCD, Clock & Data Single Key	8

* Option 1 is the default factory setting.

More information on each of the different keypad transmission formats is available below and on the following pages.

4.2.3.2 Option 1: Single Key, 6-Bit Wiegand (Rosslare Format)

Each key press immediately sends 4 bits with 2 parity bits added – even parity for the first 3 bits and odd parity for the last 3 bits.

0= 1 1010 0 = "A" in Hexadecimal

1= 0 0001 0

2= 0 0010 0

3= 0 0011 1

4= 1 0100 1

5= 1 0101 0

6= 1 0110 0

7= 1 0111 1

8= 1 1000 1

9= 1 1001 0

A= 1 1011 1 = "B" in Hexadecimal

#= 0 1100 1 = "C" in Hexadecimal

4.2.3.3 Option 2: Single Key, 6-Bit Wiegand Nibble and Parities

Each key press immediately sends 4 bits with 2 parity bits added – even parity for the first 3 bits and odd parity for the last 3 bits.

0 = 0 0000 1	6 = 1 0110 0
1 = 0 0001 0	7 = 1 0111 1
2 = 0 0010 0	8 = 1 1000 1
3 = 0 0011 1	9 = 1 1001 0
4 = 1 0100 1	Ⓐ = 1 1010 0 = "A" in Hexadecimal
5 = 1 0101 0	# = 1 1011 1 = "B" in Hexadecimal

4.2.3.4 Option 3: Single Key, 8-Bit Wiegand Nibbles Complemented

This option inverts the most significant bits in the message leaving the least 4 significant bits as a Binary Coded Decimal (BCD) representation of the key. The host system receives an 8-bit message.

0 = 11110000	6 = 10010110
1 = 11100001	7 = 10000111
2 = 11010010	8 = 01111000
3 = 11000011	9 = 01101001
4 = 10110100	Ⓐ = 01011010 = "A" in Hexadecimal
5 = 10100101	# = 01001011 = "B" in Hexadecimal

4.2.3.5 Option 4: 4 Keys Binary + Facility Code, Wiegand 26-Bit

This option buffers 4 keys and outputs keypad data with a 3-digit Facility code like a standard 26-bit card output.

The Facility code is set in Programming Menu number four and can be in the range 000 to 255. The factory default setting for the Facility code is 000 (see Section 4.2.6).

The keypad PIN code is 4-digit long and can range between 0000 and 9999. On the fourth key press of the 4-digit PIN code, the data is sent across the Wiegand Data lines as binary data in the same format as a 26-bit card.

If **⏏** or **#** are pressed during PIN code entry, the keypad clears the PIN code entry buffer, generate a beep and is ready to receive a new 4-digit keypad PIN code.

If the entry of the 4-digit keypad PIN code is disrupted and no number key is pressed within 5 seconds, the keypad clears the PIN code entry buffer, generates a beep, and is ready to receive a new 4-digit keypad PIN code.

(EP) FFFF FFFF AAAA AAAA AAAA AAAA (OP)

Where:

EP = Even parity for first 12 bits

OP = Odd parity for last 12 bits

F = 8-bit Facility code

A = 16-bit code generated from keyboard

4.2.3.6 Option 5: 1 to 5 Keys + Facility Code, Wiegand 26-Bit

Option 5 buffers up to 5 keys and outputs keypad data with a Facility code like a 26-Bit card output.

The Facility code is set in Programming Menu number four and can be in the range 000 to 255. The factory default setting for the Facility code is 000 (see Section 4.2.6).

The keypad PIN code can be one to five digits in length and can range between 1 and 65,535. When entering a keypad PIN code that is less than 5 digits in length, **#** key must be pressed to signify the end of PIN code entry. For keypad PIN codes that are 5 digits in length, on the fifth key press of the 5-digit PIN code, the data is sent across the Wiegand Data lines as binary data in the same format as a 26-Bit Card.

If **⏏** is pressed during PIN code entry or a PIN code greater than 65,535 is entered, the keypad clears the PIN code entry buffer, generates a beep, and is ready to receive a new 5-digit keypad PIN code.

If the entry of the 1- to 5-digit keypad PIN code is disrupted and a number key or # is not pressed within 5 seconds, the keypad clears the PIN code entry buffer, generates a medium length beep and is ready to receive a new 1- to 5-digit keypad PIN code.

(EP) FFFF FFFF AAAA AAAA AAAA AAAA (OP)

Where:

EP = Even parity for first 12 bits

OP = Odd parity for last 12 bits

F = 8-bit Facility code

A = 16-bit code generated from keyboard

4.2.3.7 Option 6: 6 Keys BCD and Parity Bits, Wiegand 26-Bit

Option 6 sends buffer of 6 keys, adds parity and sends a 26-Bit BCD message. Each key is a four bit equivalent of the decimal number.

The keypad PIN code must be 6 key presses long. On the sixth key press of the 6-digit PIN code, the data is sent across the Wiegand Data lines as a BCD message.

If the entry of the 6-digit keypad PIN code is disrupted and no number key is pressed within 5 seconds, the keypad clears the PIN code entry buffer, generates a medium length beep and is ready to receive a new 6-digit keypad PIN code.

(EP) AAAA BBBB CCCC DDDD EEEE FFFF (OP)

Where:

EP = Even parity for first 12 bits

OP = Odd parity for last 12 bits

A = The first key entered

D = Fourth key entered

B = Second key entered

E = Fifth key entered

C = Third key entered

F = Sixth key entered

4.2.3.8 Option 7: Single Key, 3x4 Matrix Keypad

This unique mode is intended to let the host controller scan the AYC-Ex5/T65 keypad while still keeping the proximity card readers Wiegand 26-Bit or Clock & Data formats active.

An optional interface board must be used between the AYC-Ex5/T65 and the host system. Each key press is immediately sent on DATA0 as an ASCII character at a baud rate of 9600 bits per second.

When a key is pressed DATA1 is pulled "low" until the key is released at which point DATA1 is set to "high". This allows the controller to detect the duration of the key press.

An MD-P64 interface unit outputs the data received to 7 outputs emulating a keyboard. The interface unit does not affect any data that it receives from the proximity reader whether it is Wiegand 26-Bit or Clock & Data.

Key pressed = ASCII Value

0 = '0' (0x30 hex)	6 = '6' (0x36 hex)
1 = '1' (0x31 hex)	7 = '7' (0x37 hex)
2 = '2' (0x32 hex)	8 = '8' (0x38 hex)
3 = '3' (0x33 hex)	9 = '9' (0x39 hex)
4 = '4' (0x34 hex)	␣ = '*' (0x2A hex)
5 = '5' (0x35 hex)	# = '#' (0x23 hex)

4.2.3.9 Option 8: 1 to 8 Keys BCD, Clock & Data

Buffers up to 8 keys and outputs keypad data without a facility code like standard Clock and Data card output.

The keypad PIN code can be one to eight digits in length. The PIN code length is selected while programming the reader for Option 8. The reader transmits the data when it receives the last key press of the PIN code. The data is sent across the two data output lines as binary data in Clock & Data format.

If ␣ or # is pressed during PIN code entry, the keypad clears the PIN code entry buffer, generates a beep, and is ready to receive a new keypad PIN code.

If the entry of the digit keypad PIN code is disrupted and a number key or # is not pressed within 5 seconds, the keypad clears the PIN code entry buffer, generates a medium length beep, and is ready to receive a new keypad PIN code.



Note

When using the keypad transmission format "1 to 8 keys BCD, Clock & Data" (Option 8) an additional input is required to specify the number of keys in the PIN code.

4.2.4 Selecting Proximity Card Transmission Format

The AYC-Ex5 and AYC-T65 have three different proximity card formats to select from.

To select the proximity card reader transmission format:

1. Enter Programming mode. Mode/Transmit Door/Program
Red Green

2. Press **2** to enter Menu 2.

2

The Transmit LED turns red.

Mode/Transmit Door/Program
Red Green

3. Enter the appropriate option number for the proxy card transmission format that you wish to select:
- Option 1: Wiegand 26-Bit
 - Option 2: Clock & Data
 - Option 3: Wiegand Card + PIN

You hear three beeps.

The system returns to Transmit mode.

Mode/Transmit Door/Program
Red

If the Programming code is invalid, you hear a long beep and the controller returns to Normal mode.

4.2.4.1 "Wiegand Card + PIN" Transmission Format

This unique mode is intended to let host controllers get card and keypad data simultaneously. This option overrides the selected Keypad Transmission Format and sends the keypad data as described below.

After a card is presented to the AYC-Ex5 or AYC-T65, the program LED starts to flash in green and indicates that unit is waiting for the PIN code. If the entry of 1- to 5-digit keypad PIN code is disturbed and a number key or # is not pressed within 5 seconds, the keypad clears the card buffer and the PIN code entry buffer, generates a medium length beep, and be ready to receive a new card.

The keypad PIN code can be one to five digits in length in the range of 0 to 99,999. When entering a keypad PIN code, # must be pressed to signify the end of the PIN entry. When pressing #, the data is sent by the Wiegand data lines. If the * key is pressed, the keypad clears the card buffer and the PIN code entry buffer, generates a medium length beep, and is ready to receive a new card.

The AYC-Ex5/AYC-T65 output card data comes in Wiegand 26-Bit with the following keypad data in Wiegand 26-Bit format:

- Card Data: (EP) AAAA AAAA AAAA BBBB BBBB BBBB (OP)

Where:

- EP = Even parity for first 12 A bits
- OP = Odd parity for last 12 B bits

- PIN Data: (EP) 0000 AAAA BBBB CCCC DDDD EEEE (OP)

Where:

A = The first key entered

D = Fourth key entered

B = Second key entered

E = Fifth key entered

C = Third key entered

EP = Even parity for first 12 bits

OP = Odd parity for last 12 bits

If the PIN code is less than 5 digits, all the most significant nibbles are filled with 0.

Example: (EP) 0000 0000 0000 0000 AAAA BBBB (OP)

Where:

A = The first key entered

B = Second key entered

EP = Even parity for first 12 bits

OP = Odd parity for last 12 bits

4.2.5 Changing the Programming Code

1. Enter Programming mode.

Mode/Transmit Door/Program
Green

2. Press **3** to enter Menu 3.

3

The Transmit LED turns red.

Mode/Transmit Door/Program
Red Green

3. Enter the new 4-digit code you wish to set as the Programming code.

You hear three beeps.

The system returns to Transmit mode.

Mode/Transmit Door/Program
Red



Note

- The Programming code cannot be erased, meaning the code 0000 is invalid and does not erase the Programming code.
- The factory default 4-digit Programming code is 1234.

4.2.6 Changing the Facility Code

1. Enter Programming mode.

Mode/Transmit Door/Program
Green

2. Press **4** to enter Menu 4.

4

The Transmit LED turns red.

Mode/Transmit Door/Program
Red Green

3. Enter the new 3-digit code you wish to set as the Facility code.

You hear three beeps.

The system returns to Transmit mode.

Mode/Transmit   Door/Program
Red



Note

- The Facility code can be in the range of 000 to 255.
- The default Facility code is 0.

4.3 Setting the Backlight

1. Enter Programming mode.

Mode/Transmit   Door/Program
Green

2. Press **6** to enter Menu 6.

6

The Transmit LED turns red.

Mode/Transmit   Door/Program
Red Green

3. Enter the appropriate option number for the backlight option that you wish to select:

For AYC-T65 models:

- **00** for always off
- **11** for always on
- **22** for 10 sec. backlight after a key is pressed otherwise off (Transmit LED also off)
- **33** for 10 sec. backlight after a key is pressed otherwise dimmed

For AYC-Ex5 models:

- **0** for always off
- **1** for always on
- **2** for 10 sec. backlight after a key is pressed otherwise off (Transmit LED also off)
- **3** for 10 sec. backlight after a key is pressed otherwise dimmed

You hear three beeps.

The system returns to Transmit mode.

Mode/Transmit   Door/Program
Red

4.4 Return to Factory Default Settings



You must be very careful before using this command! This erases the entire memory and return all codes to their factory default setting.

1. Enter Programming mode.

Mode/Transmit   Door/Program
Green

2. Press **0** to enter Menu 0.

0

The Transmit and Program LEDs flash red.

Mode/Transmit   Door/Program
Red Red

3. Enter your 4-digit programming code.

? **?** **?** **?**

If the Programming code is valid, all memory is erased. You hear three beeps and the controller returns to Normal mode.

If the Programming code is invalid, you hear a long beep and the controller returns to Normal mode without erasing the memory of the controller.

4.5 Replacing a Lost Programming Code

In the event that the Programming code is forgotten, the AYC-Ex5 or AYC-T65 can be reprogrammed in the field using the following instructions:

1. Remove power from the reader.
2. Activate tamper by removing the reader from the wall or removing the reader's case.
3. Apply power to the reader.
4. You now have 10 seconds to enter Programming mode using the factory default Programming code 1234.

5. Controller Functionality

The AYC-Ex5 and AYC-T65 can function both as a reader and as a controller. If the unit is connected to Rosslare's secure application appurtenance, it functions as a controller indicated by two beeps immediately after power-on reset.

The Lock Strike and Auxiliary outputs, as well as the REX input, are not located on the AYC-Ex5 or AYC-T65 unit, eliminating the possibility of unauthorized entry to the restricted area.

The following explains how the unit functions as a controller.

5.1 Normal, Secure, and Master Users

The AYC-Ex5 and AYC-T65 accept up to 500 users and provides entry via the use of PIN codes and/or Proximity cards. Each user is provided with two code memory slots, Memory Slot 1 (Primary code) and Memory Slot 2 (Secondary code).

The PIN code length has several options. The PIN code length can be a set number of 4, 5 or 6 digits or it can be a 4-8 digits option. When choosing the 4- to 8-digit option, please note that you should either enter zeros before the code, or press pound at the end (for example, if your code is 12345, enter either 00012345 or 12345#).



Entering a code refers to either PIN or CARD depending on the model you have.

The way in which the two memory slots are programmed determines a user's access level and also determines the way in which the unit grants access in its three modes of operation. There are three user levels:

- Normal User

A Normal user only has a Primary code and is only granted access when the unit is in Normal or Bypass mode.

Controller Functionality

- Secure user

A Secure user must have a Primary and Secondary code programmed; the two codes must not be the same. The Secure user can gain access when the unit is in any of its three modes of operation. In Normal mode, the Secure user must use their Primary code to gain entry. In Secure mode, the Secure user must present both the Primary and Secondary codes to gain entry.

- Master User



A Master user must have both Primary and Secondary codes programmed with the same PIN code. The Master user can gain access during any mode of operation by presenting their PIN code once to the controller. (The Master user is convenient but is less secure than a Secure user.)

5.2 Modes of Operation

The AYC-Ex5 and AYC-T65 have three modes of operation:

5.2.1 Normal Mode

The Mode LED is green.

Mode/Transmit   Door/Program
Green

Normal mode is the default mode. In Normal mode the door is locked until a Primary code is presented to the controller. Special codes such as Lock Strike code and Auxiliary code are active in Normal mode. See Sections 5.9.3 and 5.9.4 for more information on the Lock Strike and Auxiliary codes.

5.2.2 Bypass Mode

The Mode LED is orange.

Mode/Transmit   Door/Program
Orange

In Bypass mode, access to the premises is dependent on whether the controller's Lock Strike Relay is programmed for Fail Safe Operation or Fail Secure Operation. When the Lock Strike is programmed for Fail Secure Operation, the door is locked until  is pressed. When the

Lock Strike is programmed for Fail Safe Operation, the door is constantly unlocked.

5.2.3 Secure Mode

The Mode LED is red.

Mode/Transmit  Door/Program
Red

Only Secure and Master users can access the premises during the Secured mode.

A Secure user must enter their Primary and Secondary codes to gain entry. After entering their Primary code, the Door LED flashes green for 10 seconds, during which the Secondary code must be entered. A Master user only needs to present the code once to gain entry.

5.2.4 Changing the Modes of Operation

5.2.4.1 Changing from Normal Mode to Secure Mode

The default factory setting for the Normal/Secure code is 3838.

1. Enter the Normal/Secure code. Mode/Transmit  Door/Program
Green

The Mode LED flashes red. Mode/Transmit  Door/Program
Red

2. Press # to confirm the mode change.

Mode LED turns red. Mode/Transmit  Door/Program
Red

5.2.4.2 Changing from Secure Mode to Normal Mode

The default factory setting for the Normal/Secure code is 3838.

1. Enter the Normal/Secure code. Mode/Transmit  Door/Program
Red

The Mode LED flashes green. Mode/Transmit  Door/Program
Green

Controller Functionality

2. Press # to confirm the mode change.

Mode LED turns green.

Mode/Transmit  Door/Program
Green

5.2.4.3 Changing from Normal Mode to Bypass Mode

See Section 5.9.7 to create/modify the Normal/Bypass code.

1. Enter the Normal/Secure code.

Mode/Transmit  Door/Program
Green

The Mode LED flashes orange.

Mode/Transmit  Door/Program
Orange

2. Press # to confirm the mode change.

Mode LED turns orange.

Mode/Transmit  Door/Program
Orange

5.2.4.4 Changing from Bypass Mode to Normal Mode

See Section 5.9.7 to create/modify the Normal/Bypass code.

1. Enter the Normal/Secure code.

Mode/Transmit  Door/Program
Orange

The Mode LED flashes green.

Mode/Transmit  Door/Program
Green

2. Press # to confirm the mode change.

Mode LED turns green.

Mode/Transmit  Door/Program
Green

5.3 Auxiliary Input and Output

For optimum usability in different applications, the controller's auxiliary input and output can be configured in ten different modes of operation.

5.4 Door Alarms

Door alarms can be generated by connecting the Auxiliary Input to a Door Position Switch. Either Door-Forced or Door-Ajar conditions are supported, as well as, a configurable delay timer for each alarm type. Only one door alarm is enabled at any one time. Door alarms may activate auxiliary output and siren depending on the auxiliary settings.

5.5 Internal Case and Back Tamper

If the unit is forcibly opened or it is removed from the wall, a tamper event is triggered. A tamper output opens sending a to the connected Alarm system (purple wire) the event closes when the tamper is closed (case is re-closed or re-attached to the wall).

The tamper event can also activate the auxiliary output if the controller is in Auxiliary Mode 3 (see Table 5).

5.6 Lockout Feature (Keypad Tamper)

If the controller is presented with wrong codes, consecutively several times the unit goes into lockout mode.

When a lockout occurs, the controller keypad is de-activated so no codes can be entered until the set lockout period expires.

During Lockout, Mode LED is Off, Door LED flashes red, and the controller beeps every two seconds

5.7 REX Function

The REX button is connected to Rosslare's secure application appurtenance. The REX button must be located inside the premises to be secured and is used to open the door without the use of a PIN code. It is usually located in a convenient location, such as inside the door or at a receptionist's desk. The function of the REX button depends on whether the Lock Strike Relay is programmed for Fail Safe Operation or Fail Secure Operation.

- Fail Secure Operation – From the moment the REX button is pressed, the door is unlocked until the Lock Strike Release Time

passes. After this time, the door is locked even if the REX button is not released.

- Fail Safe Operation – From the moment the REX button is pressed, the door is unlocked until the REX button is released, plus the Lock Strike Release Time. In this case, the Lock Strike Relay only begins its count down once the REX button is released.

5.8 Secure Application Appurtenances

Rosslare's secure application appurtenances are designed for use with Rosslare's secured series standalone access control units, including the AYC-Ex5 series and the AYC-T65. These units are designed to operate indoors and installed within the secured premises. The units must be used with one of Rosslare's secure application appurtenances, which provide Lock Strike output and REX Input.

Both units communicate through a proprietary Rosslare protocol, which provides a secure link between the AYC-Ex5 or the AYC-T65 and the appurtenances. This in turn activates the door lock.

The units also function as the power supply for the AYC-Ex5 and AYC-T65; they also contain a speaker connection for all sounder abilities.

For more information, see the specific Appurtenances Manual.

5.9 Programming the AYC-Ex5 and AYC-T65

Programming the AYC-Ex5 and AYC-T65 is done solely via the unit's keypad driven Programming Menu System. To reach the Programming Menu System, the unit must first be put into Programming mode (see Section 5.9.1).

During a unit's manufacturing process, certain codes and settings are pre-programmed. These settings are the called the default factory settings.

Table 4 shows the names of all the AYC-Ex5 and AYC-T65 Controller menus. It also shows of all the default factory codes and settings for the units.

Table 4: Controller Programming Menu

Menu No.	Menu Description	Default			
		4 digits	5 digits	6 digits	4-8 digits
1	Changing Lock Strike Code	2580	25802	258025	25802580
2	Change Auxiliary Code	0852	08520	085208	08520852
3	Changing Program Code	1234	12341	123412	12341234
4	Changing Normal/Secure Code	3838	38383	383838	38383838
5	Changing Normal/Bypass Code	N/A			
6	Changing Door Release Time	0004			
	Define auxiliary inputs/outputs	2004			
	Set Lockout	4000			
	Backlight Behavior	5100			
7	Enrolling PIN Code				
8	Deleting PIN Code				
9	Code assignment with strike/auxiliary				
0	Return to factory defaults or change PIN code Length				

You will find a complete description and instructions for each of the above menu items on the following subsections.

5.9.1 Entering Programming Mode

1. Press # twice within 2 seconds.

The Mode LED turns off and the Door LED turns red.

Mode/Transmit Door/Program Red

2. Enter your Programming code.

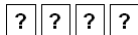

The Door LED turns green.

Mode/Transmit Door/Program Green



- The AYC-Ex5/T65 must be in Normal mode to enter the Programming mode.
- The factory four digit Programming Code is 1234.
- If a Programming Code is not entered within five seconds, the AYC-Ex5/T65 returns to Normal mode.

5.9.2 Exiting Programming Mode

1. Press **#** twice within 2 seconds.

You hear 3 beeps.

The Door LED turns off and the Mode LED turns green.

Mode/Transmit   Door/Program
Green

Wrong entries reset the controller back to Normal mode.

While in Programming mode, if no key is pressed for one minute, the unit exits Programming mode and returns to Normal mode.

5.9.3 Changing Lock Strike Code

The Lock Strike code is mainly used as a method to quickly test the Lock Strike Relay during installation.

When the first user is added to the controller, the default Lock Strike code is automatically deleted. Once the code is programmed again, it is not deleted with the entry of additional user codes.

1. Enter Programming mode.

Mode/Transmit   Door/Program
Green

2. Press **1** to enter Menu 1.

1

The Mode LED turns red.

Mode/Transmit   Door/Program
Red Green

3. Enter the new code you wish to set as Lock Strike Code 1.

? **?** **?** **?**

You hear three beeps.
The system returns to Normal mode.

Mode/Transmit Green Door/Program



Note

- Lock Strike Code 1 does not work in the Secure mode.
- Wrong entries returns the controller to Normal mode.
- Code 0000 erases the Lock Strike Code 1.
- The factory default 4-digit Lock Strike code is 2580.

5.9.4 Changing Auxiliary Code

The Auxiliary code is mainly used as a method to quickly test the Auxiliary Relay during installation.

When the first user is added to the controller, the default Auxiliary code is automatically deleted. Once the code is programmed again, it is not deleted with the entry of additional user codes.

1. Enter Programming mode.

Mode/Transmit Door/Program
Green

2. Press **2** to enter Menu 2.

2

The Mode LED turns orange.

Mode/Transmit Door/Program
Orange Green

3. Enter the new code you wish to set as the Auxiliary code.

? ? ? ?

You hear three beeps.
The system returns to Normal mode.

Mode/Transmit Door/Program
Green



Note

- Auxiliary code does not work in the Secure mode.
- Wrong entries return the controller to Normal mode.
- Code 0000 erases the Auxiliary code.
- The factory default 4-digit Auxiliary code is 0852.

5.9.5 Changing the Programming Code

1. Enter Programming mode.

Mode/Transmit Door/Program
Green

2. Press **3** to enter Menu 3.

3

The Mode LED turns green.

Mode/Transmit Door/Program
Green Green

3. Enter the new code you wish to set as the Programming code.

? ? ? ?

You hear three beeps.

The system returns to Normal mode.

Mode/Transmit Door/Program
Green



Note

- Programming code cannot be erased, meaning the code 0000 is not valid and does not erase the Programming code.
- The factory four-digit programming code is 1234.

5.9.6 Changing the Normal/Secure Code

1. Enter Programming mode.

Mode/Transmit Door/Program
Green

2. Press **4** to enter Menu 4.

4

The Mode LED flashes red.

Mode/Transmit  Door/Program
Red Green

3. Enter the new code you wish to set as Normal/Secure code.

? ? ? ?

You hear three beeps.

The system returns to Normal mode.

Mode/Transmit Door/Program
Green



- Code 0000 erases the Normal/Secure code.
- This code is disabled if the Auxiliary Input is set to toggle between Normal and Secure access modes.
- Default Normal/Secure code is 3838.

5.9.7 Changing the Normal/Bypass Code and Door Chime Settings

1. Enter Programming mode.

Mode/Transmit Door/Program
Green

2. Press **5** to enter Menu 5.

5

The Mode LED flashes orange.

Mode/Transmit Door/Program
Orange Green

3. Enter the new code you wish to set as Normal/Secure code.

? ? ? ?

There are four different ways to program the Normal/Bypass code and door chime.

- a. Enter the code **0000** to disable both Bypass code and the door chime.

0 0 0 0

- b. Enter the code **0001** to disable the Bypass code and enable the door chime.

0 0 0 1

- c. Enter any code ending with 0 to enable the Bypass code and disable the door chime.

? ? ? 0

- d. Enter a code not ending with 0 to enable the Bypass code and enable the door chime.

? ? ? ~~0~~

Controller Functionality

You hear three beeps.

The system returns to Normal mode.

Mode/Transmit   Door/Program
Green



5.9.8 Setting Fail Safe/Secure Operation, Tamper Siren and Lock Strike Release Time

1. Enter Programming mode.

Mode/Transmit   Door/Program
Green

2. Press **6** to enter Menu 6.

The Mode LED flashes green.

Mode/Transmit   Door/Program
Green Green

3. Construct a code using the following instructions:

- First Digit
For Fail Secure Operation, the first digit should be **0**.
For Fail Safe Operation the first digit should be **1**.
- Second Digit
Siren Time in minutes (1-9, 0-disabled)
- Third and Fourth Digits
Enter the number of seconds (from 1 to 99) that you want the Lock Strike to be released.

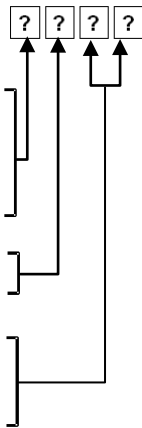

For example, 0312 means a Fail Secure Operation consisting of a 3-minute siren and a 12-second Lock Strike release time.

You hear three beeps.

The system returns to Normal mode.

Mode/Transmit   Door/Program
Green



The default value is 0004, which corresponds to Fail Secure operation, no siren, and 4-seconds Lock Strike release time.

5.9.9 Defining the Auxiliary Input and Output

1. Enter Programming mode.

Mode/Transmit Door/Program
Green

2. Press **6** to enter Menu 6.

6

The Mode LED flashes green.

Mode/Transmit Door/Program
Green Green

3. Construct a code using the following instructions:

Auxiliary mode
Auxiliary setting

2 **?** **?** **?**

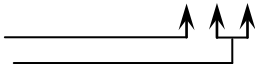

- Auxiliary mode

In addition to the Lock Strike Relay and Lock Strike REX, the unit features an Auxiliary Input. The Auxiliary mode defines the function of the Auxiliary Input.

Each of the Auxiliary modes has a two-digit setting that affects how the Auxiliary mode functions.

- Auxiliary settings

The second digit defines the Auxiliary Input function while the third and fourth digits either may have no meaning or may define delay times for door monitor functions (Table 5).

You hear three beeps.

The system returns to Normal mode.

Mode/Transmit Door/Program
Green

Controller Functionality

Table 5: Quick Reference Guide for Auxiliary Mode Setting

Aux. Mode	Aux. Input Function	Aux. Output Activated by	Aux. Relay	Aux. Settings (in seconds)
0	AUX REX	Valid code or AUX REX	N.O.	01 to 99 Aux. relay release time
1	Normal/Secure switch	Valid code	N.O.	01 to 99 Aux. relay release time
2	Normal/Secure switch	Star button (*)	N.O.	01 to 99 Aux. relay release time
3	Normal/Secure switch	Tamper event	N.C.	01 to 99 Aux. relay release time
4	Normal/Secure switch	Direct shunt	N.O.	01 to 99 Shunt time
5	Door Monitor	Shunt	N.C.	01 to 99 Maximum shunt time
6	Door Monitor	Forced door	N.C.	01 to 99 Forced delay
7	Door Monitor	Door ajar	N.C.	01 to 99 Ajar delay
8	LED control – Green	Valid code	N.O.	01 to 99 Aux. relay release time
9	LED control – Red	Valid code	N.O.	01 to 99 Aux. relay release time

5.9.10 Detailed Reference Guide

The following are brief descriptions of each auxiliary mode. To implement the features of each mode, refer to Section 5.9.9.

5.9.10.1 Auxiliary Mode 0

Auxiliary input function: Activates the auxiliary output

Auxiliary output activated by: Valid user code, Auxiliary code, and Auxiliary input

For example, in Auxiliary Mode 0, the controller can function as a two-door controller. The auxiliary relay is to be attached to the lock on the second door. The auxiliary setting defines the door open time for the second door. The auxiliary input is to be attached to the REX pushbutton for the second door. The Door Monitor input feature for the second door is not enabled when using this mode.

5.9.10.2 Auxiliary Mode 1

Auxiliary input function: Toggles Normal/Secure modes

Auxiliary output activated by: Valid user code, Auxiliary code

For example, in Auxiliary Mode 1, the controller can function as a two-door controller. The auxiliary relay is to be attached to the lock on the second door. The REX feature for the second door is not enabled when using this mode.

The auxiliary setting defines the door open time for the second door. The auxiliary input can switch the mode of operation of the controller between Normal and Secure modes. By connecting a switch timer or alarm system output to the auxiliary input, the controller can be automatically switched from Normal mode (during office hours) to Secure mode (after office hours).

5.9.10.3 Auxiliary Mode 2

Auxiliary input function: Toggles Normal/Secure modes

Auxiliary output activated by: Bell Button (🔔)

For example, in Auxiliary Mode 2, the auxiliary relay can function as a general purpose time switch that can be activated when 🔔 is pressed. The auxiliary setting establishes for how long the auxiliary relay is to be activated. The auxiliary input can switch the mode of operation of the controller between Normal and Secure modes. By connecting a switch timer or alarm system output to the auxiliary input, the controller can be automatically switched from Normal mode (during office hours) to Secure mode (after office hours).

5.9.10.4 Auxiliary Mode 3

Auxiliary input function: Toggles Normal/Secure modes

Auxiliary output activated by: Alarms

For example, in Auxiliary Mode 3, the auxiliary output is activated if the controller is tampered; that is, if the case is forcibly opened or removed from the wall. The auxiliary input can switch the mode of operation of the controller between Normal and Secure modes. By connecting a switch timer or alarm system output to the auxiliary input, the controller can be automatically switched from Normal mode (during office hours) to Secure mode (after office hours).

5.9.10.5 Auxiliary Mode 4

Auxiliary input function: Toggles Normal/Secure modes

Auxiliary output activated by: direct shunt (explanation below)

For example, in Auxiliary Mode 4, the controller is capable of bypassing an alarm zone by shunting an alarm system's door sensor. The auxiliary output is to be wired in parallel to the door sensor output. When in use, the auxiliary output is normally open and the door sensor functions normally. When a valid code is entered, the auxiliary relay shunts the door sensor for the duration of the shunt time, as defined by the auxiliary setting. If the door is left open longer than the shunt time, an alarm is triggered.

5.9.10.6 Auxiliary Mode 5

Auxiliary input function: Door Monitor

Auxiliary output activated by: Shunt (explanation below)

For example, in Auxiliary Mode 5, the controller is capable of shunting an alarm system. In this mode, the auxiliary input is to be wired to the magnetic contact switch on the door. The auxiliary relay is wired to the alarm system. Without a valid code entered, the auxiliary relay matches the condition of the magnetic contact switch; if the door opens, the auxiliary relay opens; if the door closes, the auxiliary relay closes. When a valid code is entered, a countdown for maximum shunt time, as defined by the auxiliary setting, begins; if the door is not closed before the maximum shunt time, the alarm is triggered.

5.9.10.7 Auxiliary Mode 6

Auxiliary input function: Door Monitor

Auxiliary output activated by: Forced entry

For example, in Auxiliary Mode 6, the controller can trigger the auxiliary relay if the door has been forced. If the siren settings are enabled, the siren is activated.

In this mode, the auxiliary input functions as a door monitor switch and is wired to the magnetic contact switch on the door. The auxiliary relay is to be wired to the alarm system. If the door is forced open, the controller waits for the period of the forced door delay time to elapse and then it activates the auxiliary relay. The auxiliary setting sets the forced door delay period.

5.9.10.8 Auxiliary Mode 7

Auxiliary input function: Door Monitor

Auxiliary output activated by: Door Ajar (door held open)

For example, in Auxiliary Mode 7, the controller can trigger the auxiliary relay, if it detects that the door has been held open (ajar) too long. In this mode the auxiliary input functions as a door monitor switch and is wired to the magnetic contact switch on the door. The auxiliary relay is to be wired to the alarm system. If the door is opened, the controller waits for the door ajar delay time to elapse and

if the door does not close prior to the end of this period, the controller activates the auxiliary relay. The auxiliary setting defines the door-ajar time.

5.9.10.9 Auxiliary Mode 8

Auxiliary input function: Green LED control

Auxiliary output activated by: Valid user code, Auxiliary code

For example, in Auxiliary Mode 8, the controller can function as a two-door controller and also provide indicator functionality control. The auxiliary relay is connected to the lock on the second door. The auxiliary setting defines the door open time for the second door. The auxiliary input is used to control the Door indicator. If the auxiliary input is open, the indicator flashes green; if the auxiliary input is closed, the door indicator flashes red.



Note

This mode takes control of the Door indicator LED.

The indicator LED is not be lit when:

- A valid code is entered
- While in secure mode, when waiting for a secondary code

5.9.10.10 Auxiliary Mode 9

Auxiliary input function: Red LED control

Auxiliary output activated by: Valid user code, Auxiliary code

For example, in Auxiliary Mode 9, the controller can function as a two-door controller and also provide indicator functionality control. The auxiliary relay is connected to the lock on the second door. The auxiliary setting defines the door open time for the second door. The auxiliary input is used to control the indicator. If the auxiliary input is open the door indicator flashes red; if the auxiliary input is closed the door indicator flashes green.



Note

This mode takes control of the Door indicator LED.

The indicator LED is not be lit when:

- A valid code is entered
- While in secure mode, when waiting for a Secondary code

5.9.11 Setting the Lockout Feature

If the controller is presented with wrong codes several times consecutively, the unit goes into Lockout mode.

When a lockout occurs, the controller keypad and reader are locked so no codes can be entered until the set lockout period expires.

During Lockout, Mode LED is off, Door LED flashes red, and the controller beeps every two seconds.

The default setting for the Lockout Feature is 4000 (Lockout Disabled).



Using the lockout feature is highly recommended, especially when selecting to use short PIN code length (4 or 5 digits).

1. Enter Programming mode.

Mode/Transmit Door/Program
Green

2. Press **6** to enter Menu 6.

6

The Mode LED flashes green.

Mode/Transmit  Door/Program
Green Green

3. Construct a code using the following instructions:

Set the number of wrong code attempts, which causes a lockout between 0 and 9 attempts.

Set the duration of the lockout, between 00 and 99; the value is multiplied by ten, resulting in 0 to 990 seconds.

4 ? ? ?

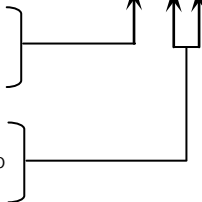

5.9.12 Setting the Backlight Behavior

The controller allows you to define the way the unit's backlight works.



1. Enter Programming mode.

Mode/Transmit  Door/Program 
Green

2. Press **6** to enter Menu 6.

6

The Mode LED flashes green.

Mode/Transmit  Door/Program 
Green Green

3. Construct a code using the following instructions:

The first digit is **5** indicating the backlight and LED option.

The second key can be 0-3 indicating the type of activity.

- Option 0 – Backlight Off
- Option 1 – Backlight On (default)
- Option 2 – Backlight Off, activated on any key press for ten seconds.
- Option 3 – Backlight Dimmed, backlight activated on any key press for ten seconds.

5 **?** **0** **0**

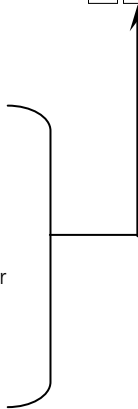

5.9.13 Enrolling Primary and Secondary Codes

5.9.13.1 Primary Codes

- Primary codes can only be enrolled to an empty user slot, meaning a slot where there is no existing Primary code.
- Primary codes must be unique, meaning one user's Primary code may not be the same as other user's Primary code.

- Primary codes cannot be the same as any system codes, such as the Normal/Secure code or Lock Strike code.
- Users who hold a Primary code can gain entry only during Normal mode.

5.9.13.2 Secondary Codes

- Secondary codes can only be enrolled to a user slot that already has a Primary code enrolled but has no Secondary code.
- Secondary codes do not have to be unique, meaning multiple users can all hold the same Secondary code.
- Secondary codes cannot be the same as any system codes, such as the Normal/Secure or Lock Strike codes.
- Users who hold Secondary codes can gain entry in any mode of operation.

5.9.13.3 Enrolling Primary and Secondary Codes

There are two methods to enroll Primary and Secondary codes:

- Standard Method

The Standard Method is mainly used when the user slot number for the user you wish to program is known. You can program both Primary and Secondary codes using the Standard method (see Section 5.9.13.4).

- Code Search Method

The Code Search Method is mainly used when enrolling a user's Secondary code and the User Slot code is unknown.

The Code Search method only works if a user's Primary code is already enrolled but the Secondary code is not (see Section 5.9.13.5).

Controller Functionality

5.9.13.4 Enrolling Primary & Secondary Codes using Standard Method

1. Enter Programming mode.

Mode/Transmit   Door/Program
Green

2. Press **7** to enter Menu 7.

7

The Door LED turns orange.

Mode/Transmit   Door/Program
Orange

3. Enter the 3-digit user slot number between 001 and 500 that you wish to enroll a Primary or Secondary code to.

? **?** **?**

For example, User Slot 003 represents User #3.



If the selected slot has no Primary code, the Mode LED flashes green, indicating that the controller is ready to accept a Primary code.

Mode/Transmit   Door/Program
Green Orange

If the selected slot already has a Primary code but no Secondary code, the Mode LED flashes red, indicating that the controller is ready to accept a Secondary code.

Mode/Transmit   Door/Program
Red Orange

If the selected slot already has a Primary and Secondary code, you hear a long beep and the controller returns to Normal mode.

Mode/Transmit   Door/Program
Green

- Enter the 4- to 8-digit PIN code that you want to assign as the Primary or Secondary code for this slot number.

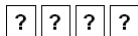

If the PIN that is entered is valid, the Mode LED stops flashing and then the controller is ready for you to enter the next 3-digit slot number (refer to Step 2) that you want to assign a code to.

- Press **#** to move to the next slot number.

If you do not wish to continue enrolling codes, press **#** twice and the controller returns to Normal mode.

5.9.13.5 Enrolling Secondary Codes using Search Method

The Code Search feature enables you to quickly enroll a Secondary code to a user who already has a Primary code.

- Enter Programming mode.

Mode/Transmit Door/Program
Green

- Press **7** to enter Menu 7.



The Door LED turns orange.

Mode/Transmit Door/Program
Orange

- Enter **000** as the 3-digit user slot number.



The Door LED flashes orange.

Mode/Transmit Door/Program
Orange

The controller is now waiting for the Primary code of the user to whom you want to add a Secondary code.

- Enter the 4- to 8-digit PIN code of the Primary code belonging to the user to whom you want to add a Secondary code.
- The Mode LED flashes red.

Mode/Transmit Door/Program
Red Orange

Controller Functionality

If the Primary code entered is not valid, you hear a long beep and the unit continues to wait for a valid Primary code.

6. Enter the 4- to 8-digit code to be used as the Secondary code.

If the Secondary code is valid, the controller beeps three times and returns to Normal mode.

If the Secondary code is invalid, the controller sounds a long beep, and the unit continues to wait for a valid Secondary code to be entered.

5.9.14 Deleting Primary and Secondary Codes

There are two methods to delete Primary and Secondary codes: the Standard Method and the Code Search Method.

When deleting a user slot, both the Primary code and the Secondary code are erased.

5.9.14.1 Deleting Primary & Secondary Codes using Standard Method

1. Enter Programming mode.

Mode/Transmit   Door/Program
Green



2. Press **8** to enter Menu 8.



The Mode LED turns red and the Door LED turns orange.

Mode/Transmit   Door/Program
Red Orange

3. Enter the 3-digit User Slot code you wish to delete.

  

The Mode LED flashes red indicating the controller is waiting for the Programming code to confirm the deletion.

Mode/Transmit   Door/Program
Red Orange

If the user slot is empty, you hear a long beep and the unit returns to Normal mode.

4. Enter your programming code to confirm the deletion.

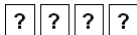

If the programming code is valid, three beeps are heard and the controller returns to Normal mode.

If the programming code is invalid, a long beep is heard and the controller returns to Normal mode.



It is recommended that a record be kept of added and deleted users so that it is easier to keep track of which user slots are empty and which user slots are not.

5.9.14.2 Deleting Primary & Secondary Codes using Search Method



1. Enter Programming mode.

Mode/Transmit   Door/Program
Green

2. Press **8** to enter Menu 8.



The Mode LED turns red and the Door LED turns orange.

Mode/Transmit   Door/Program
Red Orange

3. Enter **000** as the 3-digit user slot number.

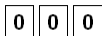

The Mode LED turns red and the Door LED flashes orange.

Mode/Transmit   Door/Program
Red Orange

The controller is now waiting for the Primary code of the user you want to delete.

4. Enter the 4- to 8-digit PIN code of the Primary code belonging to the user you want to delete.

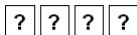

The Mode LED flashes red and the Door LED flashes orange.

Mode/Transmit   Door/Program
Red Orange

Controller Functionality

5. Enter your Programming code to confirm the deletion.

If the Programming code is valid, you hear three beeps and the unit returns to Normal mode.

If the Programming code is invalid, you hear a long beep and the unit returns to Normal mode.



It is recommended that a record be kept of added and deleted users so that it is easier to keep track of which user slots are empty and which user slots are not.

5.9.15 Relay Codes Assignment

When a primary code is enrolled for any user, the user is authorized to activate the Lock Strike relay. However, different user codes may be set to operate the auxiliary relay instead or operate both the Lock strike and auxiliary relay. Assignment of such codes is achievable for any valid user code entered in the controller.

There are two methods to assign relay codes to users: a standard method and a search method.

5.9.16 Relay Code Assignment using Standard Method

1. Enter Programming mode.

Mode/Transmit Door/Program
Green

2. Press **9** to enter Menu 9.

9

The Mode LED turns green and the Door LED turns orange.

Mode/Transmit Door/Program
Green Orange

3. Enter the 3-digit user slot for code assignment.

? ? ?

The Mode LED flashes green.

Mode/Transmit Door/Program
Green Orange

4. Enter the assignment digit for the current user slot:
 - **1** activates the Lock Strike relay only default
 - **2** activates the Auxiliary relay only
 - **3** activates the Lock Strike and Auxiliary relays

If the assignment code is valid, the Mode indicator stops flashing.
The controller is now waiting for another slot number.

5. Press **#** to move to the next slot or enter a new slot number.
If you do not wish to continue, press **#** twice and the controller returns to Normal mode.

5.9.17 Relay Code Assignment using Search Method

1. Enter Programming mode.

Mode/Transmit	<input type="radio"/>	<input checked="" type="radio"/>	Door/Program
		Green	

2. Press **9** to enter Menu 9.

9

The Mode LED turns green and the Door LED turns orange.

Mode/Transmit	<input checked="" type="radio"/>	<input checked="" type="radio"/>	Door/Program
	Green	Orange	

3. Enter **000** for user slot access.

0 0 0

The Door LED flashes orange.

Mode/Transmit	<input checked="" type="radio"/>	<input checked="" type="radio"/>	Door/Program
	Green	Orange	

The controller is now waiting for the primary code of the user.

4. Enter the primary code belonging to the user

The Mode LED flashes green.

Mode/Transmit	<input checked="" type="radio"/>	<input checked="" type="radio"/>	Door/Program
	Green	Orange	

5. Enter the assignment digit for the current user slot:

- **1** activates the Lock Strike relay only default
- **2** activates the Auxiliary relay only
- **3** activates the Lock Strike and Auxiliary relays

If the assignment digit is valid, three beeps are heard and the controller returns to Normal mode.

If the assignment digit is invalid, a long beep sounds and the controller waits for another assignment digit to be entered.

5.9.18 PIN Code Length/Factory Default Settings



You must be very careful before using this command! Changing the PIN code length also erases the entire memory contents, including all user and special codes, and return all codes to their factory-default settings.

1. Enter Programming mode.

Mode/Transmit 

 Door/Program
Green

2. Select the desired PIN code length as follows:

- **00** – Returns to factory defaults and sets a 4-digit code.
- **05** – Returns to factory defaults and sets a 5-digit code.
- **06** – Returns to factory defaults and sets a 6-digit code.
- **08** – Returns to factory defaults and sets a 4- to 8-digit code

Both the Mode and Door LEDs
flash red.

Mode/Transmit  Red

 Door/Program
Red

3. Enter your 4- to 8-digit Programming code

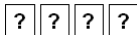

If the Programming code is valid, all memory is erased. You hear three beeps and the controller returns to Normal mode.

If the Programming code is invalid, you hear a long beep and the controller returns to Normal mode without erasing the memory contents.

5.9.19 Replacing a Lost Programming Code



The AYC-Ex5 and AYC-T65 must be in Normal mode; otherwise, this does not work. Make sure that the Mode LED is green before proceeding.

To replace a lost Programming code:

1. Remove power from the Power Supply Unit.
2. Press the REX button on the Power Supply Unit.
3. Apply power to the unit with REX button pressed.
4. Release the REX button.
5. You now have 10 seconds to program a new Programming code into the Access Control unit using the initial default code 1234, before the controller reverts to the existing code.

5.9.20 Exiting Secure Mode if Normal/Secure Code was Lost

To exit Secure mode if Normal/Secure Code was lost:

1. Remove power from the power supply unit.
2. Press the REX button on the power supply unit.
3. Apply power to the unit with the REX button pressed.
4. Release the REX button.
5. You now have 10 seconds to exit Secure mode using the initial default Normal/Secure code 3838.
6. Program a new Normal/Secure code as described in Section 5.9.6.

A. Declaration of Conformity



This declaration applies to the AYC-T65 model only.

This device complies with Part 15 of the FCC Rules. Operation is subject to the following two conditions:

- This device may not cause harmful interference.
- This device must accept any interference received, including interference that may cause undesired operation.

Changes or modifications not expressly approved by the party responsible for compliance could void the user's authority to operate the equipment.

NOTE: This equipment has been tested and found to comply with the limits for a Class B digital device, pursuant to Part 15 of the FCC Rules. These limits are designed to provide reasonable protection against harmful interference in a residential installation.

This equipment generates uses and can radiate radio frequency energy and, if not installed and used in accordance with the instructions, may cause harmful interference to radio communications. However, there is no guarantee that interference will not occur in a particular installation. If this equipment does cause harmful interference to radio or television reception, which can be determined by turning the equipment off and on, the user is encouraged to try to correct the interference by one or more of the following measures:

- Reorient or relocate the receiving antenna.
- Increase the separation between the equipment and receiver.
- Connect the equipment into an outlet on a circuit different from that to which the receiver is connected.
- Consult the dealer or an experienced radio/TV technician for help.

B. Limited Warranty

The full ROSSLARE Limited Warranty Statement is available in the Quick Links section on the ROSSLARE website at www.rosslaresecurity.com.

Rosslare considers any use of this product as agreement to the Warranty Terms even if you do not review them.



Asia Pacific, Middle East, Africa

Rosslare Enterprises Ltd.
Kowloon Bay, Hong Kong
Tel: +852 2795-5630
Fax: +852 2795-1508
support.apac@rosslaresecurity.com

United States and Canada

Rosslare Security Products, Inc.
Southlake, TX, USA
Toll Free: +1-866-632-1101
Local: +1-817-305-0006
Fax: +1-817-305-0069
support.na@rosslaresecurity.com

Europe

Rosslare Israel Ltd.
Rosh HaAyin, Israel
Tel: +972 3 938-6838
Fax: +972 3 938-6830
support.eu@rosslaresecurity.com

Latin America

Rosslare Latin America
Buenos Aires, Argentina
Tel: +54-11-4001-3104
support.la@rosslaresecurity.com

China

Rosslare Electronics (Shenzhen) Ltd.
Shenzhen, China
Tel: +86 755 8610 6842
Fax: +86 755 8610 6101
support.cn@rosslaresecurity.com

India

Rosslare Electronics India Pvt Ltd.
Tel/Fax: +91 20 40147830
Mobile: +91 9975768824
sales.in@rosslaresecurity.com

ROSSLARE
SECURITY PRODUCTS
www.rosslaresecurity.com

